

2012



NEW VIDEO SECURITY PRODUCTS



S.M.A.R.T. Technology
HDD Health Check



Future Proof DVRs
Support Analog & IP Cameras



Delivers High Definition,
High Speed Digital Video
Over Coax



Intense-IR Function:
No Saturation, Vivid Image



Digital Deterrent™
Audio/Visual
Crime Prevention



See Color In
Near Darkness
Without IR LEDs



Speco Configurator iPad® App
Set-Up Basic DVR's &
IP Cameras Wirelessly

**Security Products
That Deter Crime!**

speco technologies®

2012 NEW VIDEO SECURITY PRODUCTS

PIR PIR Series Cameras



DAY & NIGHT
DIGITAL DETERRENT™

pg. 2

IR Intense-IR Series Cameras



DAY & NIGHT

pg. 3

IR Day/Night Weather Resistant Bullet Cameras



DAY & NIGHT

pg. 4

DAY & NIGHT Intense Light Camera + Miniature Color Cameras



pg. 5

INT Intensifier3™ Series Cameras



pg. 6

DIGITAL DETERRENT™ 16 Channel DVR Server with Intelligent Analytics



pg. 7

DIGITAL DETERRENT™ 4 Channel IP Camera NVR



pg. 8

+ RS & WRS Series Multi-Channel Digital Video Recorders

S.M.A.R.T.

Configurator



pg. 9

DIGITAL DETERRENT™ Configurator S.M.A.R.T. **+**

CS & LS Series DVRs with Digital Deterrent™



pg. 10

DIGITAL DETERRENT™ Configurator S.M.A.R.T. **+**

PS & GS Series Hybrid DVRs with Digital Deterrent™



pg. 11

HD Configurator

1080P/720P High Definition CCTV Recorders



pg. 12

Mobile DVR with Cloud Archiving



pg. 13

The Configurator & Commander Apps, Flat Panel Color LED Monitors



pg. 14

Speco Technologies is constantly developing and improving products. We reserve the right to modify product design and specifications without notice and without incurring any obligation. Rev. 9/20/11. We are not responsible for typographical errors. © 2011 Speco Technologies. All rights reserved.

Weather/Tamper Resistant Dome & Bullet Cameras with PIR Sensor & White LEDs



Speco Technologies new PIR Cameras include a unique PIR sensor along with white IR LED's that will **not just capture the crime, they can help stop it before it happens**. When motion is detected by the PIR sensor, white LED's automatically turn on and illuminate the area. The perpetrator turns to see where the light is coming from and the camera will capture their face, what they are wearing and other details.

Specifications

Image Sensor	1/3" Sony Super-HAD II™ CCD
Resolution.....	600 TV Lines
Minimum Illumination.....	CDS Off: 0.15 Lux: CDS On: 0.00002 Lux
Lens.....	2.8-12mm or 5-50mm Auto Iris Varifocal Lens
IR Range	Up To 65'
PIR Range.....	Up To 20'
White Balance	ATW / Outdoor / Indoor / Manual AWC (1,700°K ~ 11,000°K)
Gain Control	Low / High / Off
BLC	BLC / HLC / OFF
S/N Ratio	More than 52dB
Video Output.....	CVBS: 1.0Vp-p / 75Ω
Privacy Masking	On / Off (12 Programmable Zones)
Day & Night	Color / BW / AUTO
Power Supply	12VDC / 24VAC dual voltage - not included
Power Consumption	12VDC Min: 250mA (CDS Off, PIR Off) 12VDC Max: 600mA (CDS On, PIR On) 24VAC Min: 100mA (CDS Off, PIR Off) 24VAC Max: 250mA (CDS On, PIR On)
Operational Temperature.....	-10 ~ +50 Deg C. RH 95% Max.
Storage Temperature.....	-20 ~ +60 Deg C. RH 95% Max.
Warranty.....	5 years



Speco Technologies new PIR cameras not only capture the crime, they can help stop it!

CVC5300DPVF/CVC5300DPVFW (White Housing)
2.8-12mm Auto Iris Varifocal Lens

CVC5400DPVF/CVC5400DPVFW (White Housing)
5-50mm Auto Iris Varifocal Lens

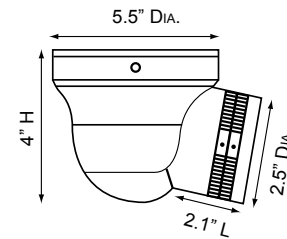

CVC5100BPVF/CVC5100BPVFW (White Housing)
2.8-12mm Auto Iris Varifocal Lens

CVC5200BPVF/CVC5200BPVFW (White Housing)
5-50mm Auto Iris Varifocal Lens

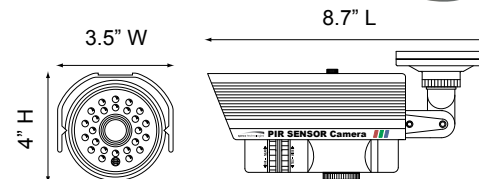

STOP THE CRIME!

For full line of products and detailed product specs - visit specotech.com

Intense-IR Bullet & Dome Cameras

Best Video Quality - Even At Night!

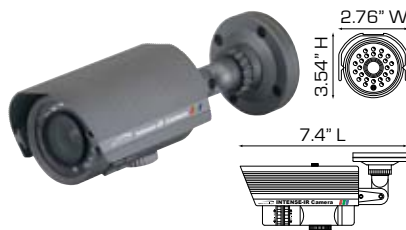

CVC5715DNV
CVC5715DNVW (White Housing)
 4-9mm Auto Iris Varifocal Lens

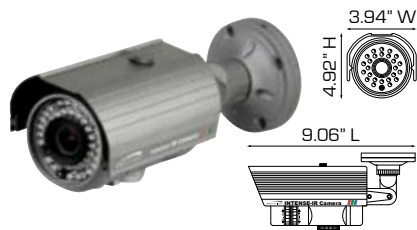

CVC5815DNV
CVC5815DNVW (White Housing)
 2.8-12mm Auto Iris Varifocal Lens

CVC5915DNV
CVC5915DNVW (White Housing)
 5-50mm Auto Iris Varifocal Lens

Tamper/Weather Resistant



CVC5735DNV
CVC5735DNVW (White Housing)
 4-9mm Auto Iris Varifocal Lens

CVC5835DNV
CVC5835DNVW (White Housing)
 2.8-12mm Auto Iris Varifocal Lens

CVC5935DNV
CVC5935DNVW (White Housing)
 9-22mm Auto Iris Varifocal Lens



CVC5725DNV
CVC5725DNVW (White Housing)
 4-9mm Auto Iris Varifocal Lens

CVC5825DNV
CVC5825DNVW (White Housing)
 2.8-12mm Auto Iris Varifocal Lens

CVC5925DNV
CVC5925DNVW (White Housing)
 9-22mm Auto Iris Varifocal Lens

CVC5845DNV
CVC5845DNVW (White Housing)
 2.8-12mm Auto Iris Varifocal Lens

IR Range Up To 90'

CVC5945DNV
CVC5945DNVW (White Housing)
 5-50mm Auto Iris Varifocal Lens

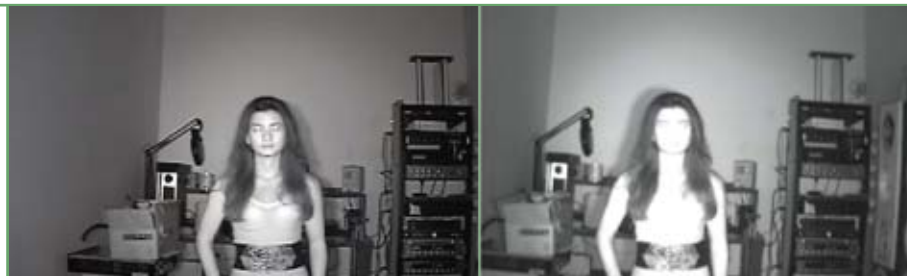

INTENSE-IR

STANDARD IR

Speco Technologies Intense IR Series of cameras capture vivid images at varying distances and in any condition. With a typical IR camera, an object close to the camera will "white-out" with too much IR light, rendering the images unusable. Speco's Intense IR eliminates IR saturation of any video image by controlling the IR sensitivity. A unique filtering method improves low light visibility by eliminating all video noise and a built in defect function eliminates white spots caused by IRs. Speco's Intense IR cameras offer the best video quality even at night. Available in dome and bullet models.

Specifications

Image Sensor	1/3" Sony Super-HAD II™ CCD
Resolution	600 TV lines
Minimum Illumination	0.000006 Lux (IR LEDs ON)
Number of IR LEDs	Varies by model*
IR Range	Up To 65'
White Balance	ATW / AWB / Manual / AWC SET
Gain Control	High, Middle, Low, Off Selectable
S/N Ratio	52dB (AGC Off, Weight On)
Backlight	OFF / HSBLCL / BLC Selectable
3 DNR	Off/On (1~50 Levels Adjustable)
D-WDR	Indoor / Outdoor / Off
Sharpness	0~31' (Level Adjustable)
Privacy	On/Off (8 Zones)
Power	12VDC/24VAC dual voltage - not included
Power Consumption	Varies by model*
Operational Temperature/Humidity	14°F ~ 122°F / RH 95% Max.
Storage Temperature/Humidity:	-4°F ~ 140°F / RH 95% Max.
Warranty	5 years



*For detailed product specs on all Intense-IR cameras - visit specotech.com

Day/Night Weather Resistant Cameras with Extreme IR Technology



Speco Technologies latest high resolution, day/night weather resistant cameras display a vivid, sharp picture [with no ghosting] in complete darkness. The HT7048IRVF & HT7049IRVF feature 98 total IR LEDs on both sides of the camera and the VL7038IRVF & VL7039IRVF include 63 IR LEDs inside. Other features include external control rings for easy focus and distance adjustment with a front glass heater that immediately removes condensation.

Specifications

Image Sensor.....	1/3" Sony Super-HAD II™ CCD
Resolution	600 TV Lines
Minimum Illumination	IR LEDs OFF: 0.1 Lux / IR LEDs ON: 0.0002 Lux
TV System.....	NTSC/PAL
Total Pixels	NTSC=811(H) x 508(V)
Effective Pixels	NTSC=768(H) x 494(V)
Scanning Frequency	NTSC=15.734KHz(H) / 59.94Hz(V)
Scanning System	2:1 Interlaced
Synchronization.....	Internal
Max. IR Range	HT7048IRVF / VL7038IRVF / VL7039IRVF - Indoor - 196' / Outdoor - 131' HT7049IRVF - Indoor - 229' / Outdoor - 164'
S/N Ratio	More than 52dB
Video Output	CVBS: 1.0Vp-p / 75 Ohm
Electronic Shutter Speed	(1/60sec. ~ 1/120,000 sec.)
BLC	BLC / HLC / OFF / Selectable
Day/Night	Color / BW / AUTO / EXT
Power Supply	12VDC/24VAC dual voltage - not included
Operational Temperature/Humidity....	14°F ~ 122°F / RH 95% Max.
Storage Temperature/Humidity:.....	-4°F ~ 140°F /RH 95% Max.
Warranty.....	5 years



98 IR LEDs

HT7048IRVF
2.8-12mm Auto Iris Varifocal Lens
HT7049IRVF
6-50mm Auto Iris Varifocal Lens

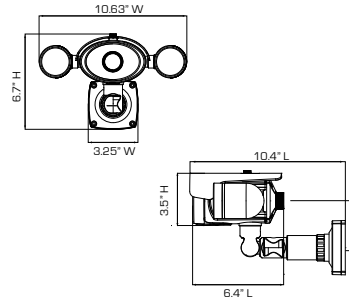

Power Consumption 12VDC Min: 220mA (CDS Off, Heater Off)
12VDC Max: 1100mA (CDS On, Heater On)
24VAC Min: 130mA (CDS Off, Heater Off)
24VAC Max: 500mA (CDS On, Heater On)

63 IR LEDs

VL7038IRVF
2.8-12mm Auto Iris Varifocal Lens
VL7039IRVF
6-50mm Auto Iris Varifocal Lens

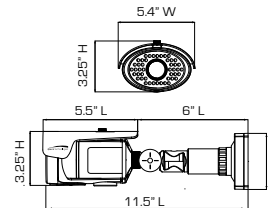

Power Consumption 12VDC Min: 220mA / Max: 700mA
24VAC Min: 150mA / Max: 450mA

For full line of products and detailed product specs - visit specotech.com

Intense Light Color Dome Camera



Weather Resistant Dome

VL647iLT

2.8-12mm
DC Auto Iris Varifocal Lens



Day/Night operation without using IR LEDs

Specifications

Image Sensor	1/3" Sony Super-HAD II™ CCD
Resolution.....	580 TVL
Minimum Illumination.....	0.00001 lux (Intense Light x256)
Total Pixels	811(H) x 508(V)
Effective Pixels	768(H) x 494(V)
Scanning System.....	2:1 Interlaced
Synchronization	Internal
OSD.....	Available
Intense-LT.....	Off/Auto (Selectable limit x2~x256)
Gain Control	High/Middle/Low/Off/Selectable
Electronic Shutter Speed.....	Auto 1/50 sec, 1/60 sec~ ~ 1/100,000 sec
Day / Night.....	Color / Auto /BW
Power Supply	12VDC only, Max: 200mA - not included
Operational Temperature/Humidity.....	14°F ~ 122°F / RH 95% Max.
Storage Temperature/Humidity:.....	-4°F ~ 140°F /RH 95% Max.
Warranty	5 years

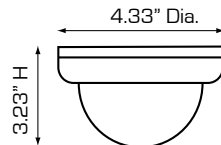

Miniature Weather Resistant Color Cameras with or without IR LEDs



CVC71HRB
CVC71HRW (White Housing)
3.4mm fixed lens with IR LEDs

CVC61HRB
CVC61HRW (White Housing)
3mm fixed lens



CVC62HRB/CVC62HRW (White Housing)
4.3mm fixed lens

600 TVL High Resolution, Intense Light Model
CVC61iLTB/CVC61iLTW (White Housing)
3mm fixed lens
CVC62iLTB/CVC62iLTW (White Housing)
4.3mm fixed lens

Specifications

Image Sensor	1/3" Sony Super-HAD™ CCD
Resolution.....	540 TV Lines
Weather Resistant.....	IP66 Rated
White Balance	Auto
Gain Control	Auto
S/N Ratio	>50dB (AGC Off)
Video Output.....	1.0Vp-p~75 Ohm
Electronic Shutter Speed.....	Auto: 1/60 ~ 1/120,000 Seconds
Scanning Frequency.....	Horizontal 15.734KHz / Vertical: 60Hz
Scanning System.....	2:1 Interlace
Synchronization	Internal
Power Supply	12VDC only, Max: 120mA - not included
Operational Temperature/Humidity.....	-14°F ~ 120°F / RH 95% Max.
Storage Temperature/Humidity:.....	-4°F ~ 140°F /RH 95% Max.
Warranty	5 years

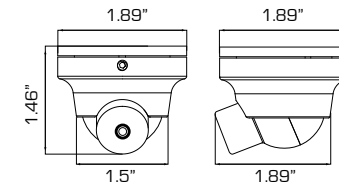

Intensifier3™ Series Cameras



Intensifier Camera



IR LED Camera



Standard Camera

SEE IN THE DARK WITHOUT IR LEDs! Weather & tamper resistant models feature 650 lines of resolution that deliver extreme details. Auto iris varifocal lenses provide a wider zoom range to fit more applications. Dual voltage operation: 12VDC or 24VAC with line lock. The advanced Noise Reduction circuitry in the Intensifier3™ camera coupled with the virtual 3D filter that is built into the DSP will allow your DVR to have 30% better compression in scenes that were typically subject to video noise. This means that your low light and nighttime pictures will not only look better, but they will also use less Hard Drive space.

Now with Presets: Outdoor, Indoor, Elevator, Lobby, Hallway & Dark

Specifications

Image Sensor	1/3" Sony Super-HAD II™ CCD
Resolution	650 TV line
Minimum Illumination	0.00002 lux - Intensifier™ @ 512x
Intensifier™	Built-in
Speco Light Compensation (SLC)	Low, Middle, High, Off, Selectable, HLC
White Balance	ATW/AWC/Manual (1800K - 10,500K)
AGC	Low, Middle, High, Off selectable
S/N Ratio	52dB (weight on)
Video Output	Video 1.0 Vp-p into 75 Ohm
Electronic Shutter	Auto/Manual (1/60 - 1/120,000 sec.)
OSD	Built-in
Weather Resistant Standard	IP66
Day & Night (Color)	On / Auto Selectable
Sharpness	On / Off (Level Adjustable)
Privacy Function	On / Off (8 Programmable Zones)
Operating Temperature	-20°F to 122°F - RH 95% Max.
Operational Humidity	30% - 90% RH
Power Consumption	12VDC 250mA / 24VAC 100mA
Power Requirements	12VDC/24VAC - dual voltage - not included
Warranty	5 years



OUTDOOR

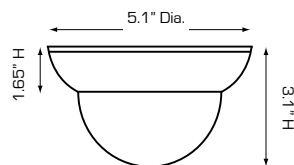

- HT7246iHR**
2.8-12mm lens dark grey housing
- HT7247iHR**
9-22mm lens dark grey housing
- HT7250iHR**
5-50mm lens dark grey housing

OUTDOOR



Patent Pending
All Position Swivel
Mounting Bracket!

Now with
Sealed Housing!

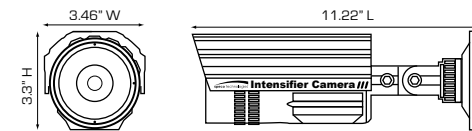

- HTINTB8/HTINTB8W** (White Housing)
2.8-12mm lens
- HTINTB9/HTINTB9W** (White Housing)
5-50mm lens
- HTINTB10/HTINTB10W** (White Housing)
9-22mm lens

INDOOR



- CVC6246iHR**
- CVC6246iHRW** (White Housing)
2.8-12mm lens

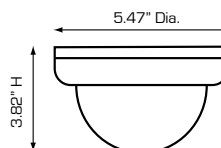

OUTDOOR



Exterior Controls

- HTINTD8/HTINTD8W** (White Housing)
2.8-12mm lens
- HTINTD9/HTINTD9W** (White Housing)
5-50mm lens
- HTINTD10/HTINTD10W** (White Housing)
9-22mm lens

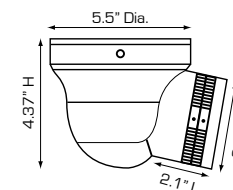

For full line of products and detailed product specs - visit specotech.com

16 Channel DVR Server with Intelligent Analytics



DVRPC16T

Speco Technologies new DVRPC16T is packed with many features, but its Intelligent Analytics make it simply unique. The DVRPC16T server is a true hybrid DVR that provides dual network cards and IP camera support for the most popular brands including megapixel resolution. Advanced search features make pinpointing images a breeze. A perfect solution for the customer who needs a sophisticated DVR.

An innovative cloud archiving tool, Remote Backup, can pull data off the DVR's database and store at a remote location. Users can also configure what time to archive and what data gets pulled off of the database automatically.

Intelligent Video Analytics:

- Missing Objects
- Suspicious Objects
- Object Detection
- Scene Change
- Video Encryption
- Watermark Verification
- FaceFinder

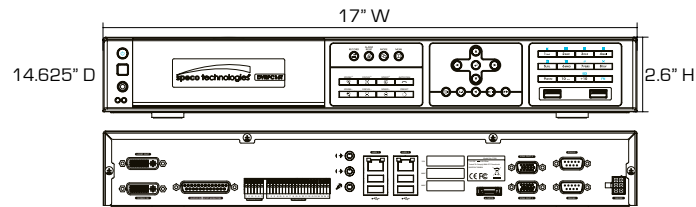

STOP THE CRIME!



No Licensing Fees!

**Supports
Megapixel Recording!**

FEATURES

- **Windows® XP Embedded PC Based Operating System**
- True Hybrid DVR provides IP camera support on most popular brands including megapixel resolution
- Supports up to 42 megapixels
- H.264 Hardware compression
- 480 fps total recording frame rate, configurable to divide across 16 channels
- **Digital Deterrent™ ready**
- Supports POS integration
- DVD/RW standard
- **Free iPhone® app available from iTunes®**
- 16 camera inputs and loopouts
- 16 audio inputs
- Dual VGA Output
- Two 10/100/1000 Ethernet interfaces
- 720x480, 640x480, 352x240 image sizes
- Advanced programmable motion detection with video analytics
- 16 sensor inputs
- 4 alarm outputs
- Pan / Tilt / Zoom control
- Password protection
- Still image save with image verification utility
- Still image print capability
- Fully integrated one-button backup to DVD/RW
- System failure handling with UPS support (auto rebooting with file recovery)
- Auto-sensing, auto protection power supply (100~127/200~240V AC)
- 1920 x 1200 monitor resolution
- 32-bit color
- NTSC / PAL support
- Power Supply: 120 Watt (Included)
- Accessories: mouse & rack ears
- HDD size: from 1TB to 6TB available
- Optional loopout cable available: DVRPCLO
- 3 year warranty

For full line of products and detailed product specs - visit specotech.com

4 Channel IP Camera NVR



The NVRP4 features an embedded Linux system that has the same feel as a PC format DVR and works with Speco's PC DVR Series CMPC. It supports H.264, MJPEG and MPEG4 compression for recording and includes dual gigabit NICs giving the NVR the ability to handle larger data streams. Each individual channel can support up to 2.3MP cameras while the last channel will support up to a 5MP camera. The uncomplicated system supports 50+ IP camera brands and has the ability for integration of other IP camera languages by customer request.

Specifications

IP Recording Resolution.....	Each individual channel can support a maximum of 2.3 Megapixels, last channel can support up to 5 Megapixels
Display Frame Rate.....	CIF: 120 fps, D1: 60 fps
Recording Frame Rate	CIF: 120 fps, D1: 120 fps
Audio In/ Audio Out.....	4/1 RCA
Sensor In/ Relay Out.....	4/1
Number of HDD Supported (Optional).....	1 internal SATA HDD and 1 eSATA connector for external HDD
eSATA Port	1
VGA Out	1
Ethernet.....	10/100/1000Mbps
LAN Port.....	Dual Gigabit LAN ports



NVRP4

Supports Megapixel Recording!

- Free iPhone app available from iTunes
- Embedded Linux system
- 4 IP (video & audio) up to 2.3 megapixel
- IP video streams: H.264, MPEG4, MJPEG
- Supports 50+ IP camera brands
- Dual 10/100/1000 ethernet interfaces
- Supports eSATA storage
- Compact and lightweight profile (6.4"L x 9.6"W x 2.1"H)
- Uncomplicated system and IP camera support updates through USB drives
- Watchdog function
- 3 year warranty
- 3 USB 2.0 ports



STOP THE CRIME!

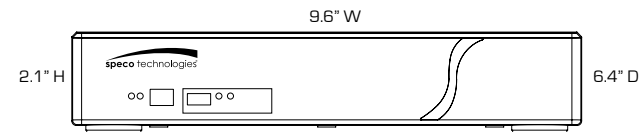

For full line of products and detailed product specs - visit specotech.com

**NEW
S-Series**

H.264 Multi-Channel Digital Video Recorders



Remote monitoring, recording and playback do not have to be costly. Speco Technologies RS is a H.264 networkable digital video recorder developed for those smaller applications that need to be within specific budget guidelines without giving up desirable features.

Specifications

- 120 FPS @ (D1)
- HDD Storage from 250GB to 2TB*
- H.264 compression
- 4 Channel audio input, 1 channel audio output
- Covert camera operation provides enhanced security and administrator control
- Programmable recording, motion detection, sensor, scheduling, continuous and manual
- Outputs: 1 BNC, 1 VGA, 1 SPOT
- USB 2.0 port for video clip exporting
- Multiple language on-screen menus
- Password to secure installation authorization
- Network software supports static IP, DHCP and DDNS
- Network hardware supports 10/100 base TX ethernet
- Operating temperature: 40° F to 104° F

* D4RS & D4WRS available up to 1TB

For full line of products and detailed product specs - visit specotech.com

Digital Value Recording



D4RS 4 Channel
D8RS 8 Channel
D16RS 16 Channel

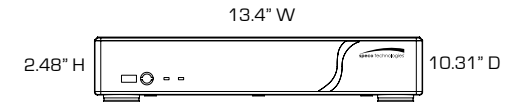

- View on iPhone® or Android
- EZ Record & EZ Copy
- Recording Rate: 120 FPS @ D1
- H.264 high quality compression saves HDD space
- Simultaneous live view/playback while continuing to record/network transfer or backup
- Remote monitoring/recording/playback/configuration/software updates and control via Internet
- 1 Audio channel for each camera input
- Automatic camera detection (Plug & Play)
- Dynamically programmable recording priority, motion detection, alarms and scheduling
- Outputs: 1 BNC, 1 VGA, 1 SPOT
- 2 way audio
- Free iPhone app available from iTunes
- 3 year warranty

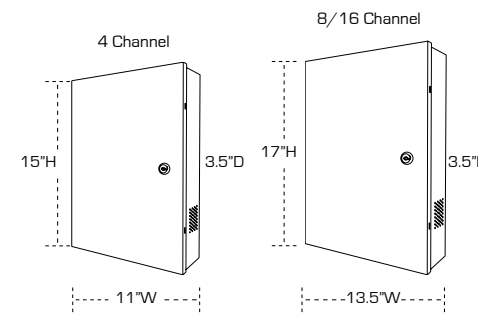

Wall Mount Version

D4WRS 4 Channel
D8WRS 8 Channel
D16WRS 16 Channel



NEW S-Series

H.264 Multi-Channel DVRs with Digital Deterrent™



High end power does not always have to come in a rack mounted unit. Speco Technologies' **CS DVR** has a compact and stylish design yet features advanced analytics, such as museum search, and Digital Deterrent™ with 2 way audio.



D4CS 4 Channel
D8CS 8 Channel
D16CS 16 Channel

EZ Set-UP Wizards
Storage from 250GB up to 2TB

- View on iPhone®, Blackberry®, Android and Mac®
- EZ Record, Copy & Setup
- EZ Network: for quick setup on a network
- H.264 high quality compression saves HDD space
- Up to 480 fps recording rate
- Multiple analytics such as museum search and advanced motion detection
- Email notification of alarm events
- Hard drive status monitoring
- Remote upgrade
- 2 way audio
- POS
- Simultaneous live view/playback while continuing to record/network transfer or backup
- Remote monitoring/recording/playback/ configuration and control via Internet
- Dynamically programmable recording priority, motion detection, alarms and scheduling
- VGA Output
- IR remote control included – individually control up to 16 DVRs
- Free iPhone app available from iTunes
- 3 year warranty



The **LS DVRs** are ideal for a wide range of surveillance applications from retail to education facilities. Its powerful search engine and complete set of network applications with mobile devices make it easy to control any situation.



D8LS 8 Channel
D16LS 16 Channel

EZ Set-UP Wizards
Storage from 500GB up to 6TB

- View on iPhone®, Blackberry®, Android and Mac®
- EZ Record, Copy & Setup
- EZ Network: for quick setup on a network
- H.264 high quality compression saves HDD space
- Up to 480 fps recording rate
- Video Loopouts
- Multiple analytics such as museum search and advanced motion detection
- Email notification of alarm events
- Hard drive status monitoring
- Remote upgrade
- 2 way audio
- POS
- Simultaneous live view/playback while continuing to record/network transfer or backup
- Remote monitoring/recording/playback/ configuration and control via Internet
- Dynamically programmable recording priority, motion detection, alarms and scheduling
- VGA Output
- IR remote control included – individually control up to 16 DVRs
- Free iPhone app available from iTunes
- 3 year warranty

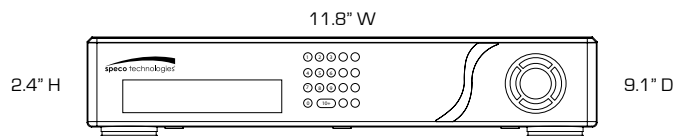

STOP THE CRIME!

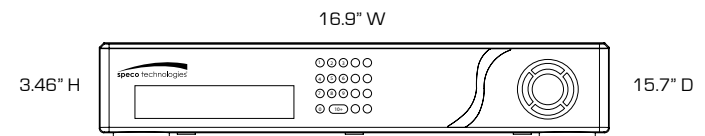

NEW S-Series

Hybrid Multi-Channel Digital Video Recorders with Digital Deterrent™



PS DVR - Hybrid with Full HD Surveillance & Set-Up Wizards

Designed to bridge the technological division by delivering hybrid IP and analog recording capabilities along with full HD display. Feature-rich performance, extensive storage, display options and powerful search capabilities, make these DVRs a simple and cost-effective migration strategy to IP with no added licensing fee. Customers who have encountered expansion challenges of megapixel IP recording, now have a cost-effective solution in these hybrid dvrs. The ability to support megapixel IP cameras gives new power and flexibility.

GS DVR - High Performance Hybrid DVR with Full D1 Recording

The best choice for professional security - Reliable and affordable path to IP H.264 Full D1 Real Time Recording. The GS DVR is the security industry's most powerful digital video recorder, capable of simultaneously recording at 480/400ips at D1(4CIF) resolution. The exceptional performance, combined with IDIS proprietary data bank system and ISM technology, makes the GS the best option for professional range of market. Industry-leading Graphic User Interface that is user-friendly, intuitive, and perfectly optimized for Full HD monitors.



Supports Megapixel Recording!



D24PS
8 Channel Analog + 16 Channel IP

D32PS
16 Channel Analog + 16 Channel IP

- Up to 5 monitors connectable simultaneously
- Full HD (1920 x 1080p) monitor resolution support
- Various screen formats for full HD and standard monitors
- Various recording modes: continuous, motion, alarm, Pre/post-event, text-in,panic
- Various searching modes: date/time, calendar, time bar, event, motion, alarm, text-in

EZ Set-UP Wizards
Storage from 500GB up to 6TB

- Disk mirroring, data archiving support
- Various actions (PTZ preset, record cameras, alarm, save image) configurable
- External hard drives attachable via eSATA port
- iSCSI support
- Various PTZ protocol support (60+)
- POS support

D24GS
8 Channel Analog + 16 Channel IP

D32GS
16 Channel Analog + 16 Channel IP

- Up to 5 monitors connectable simultaneously
- Full HD (1920 x 1080p) monitor resolution support
- Various screen formats for full HD and standard monitors
- Various recording modes: continuous, motion, alarm, Pre/post-event, text-in,panic
- Various searching modes: date/time, calendar, time bar, event, motion, alarm, text-in

EZ Set-UP Wizards
Storage from 500GB up to 8TB

- Disk mirroring, data archiving support
- Various actions (PTZ preset, record cameras, alarm, save image) configurable
- External hard drives attachable via eSATA port
- iSCSI support
- Various PTZ protocol support (60+)
- POS support

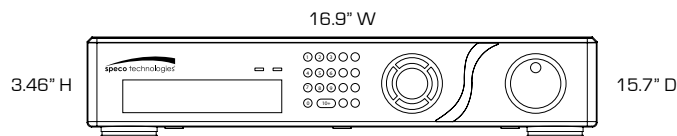

STOP THE CRIME!

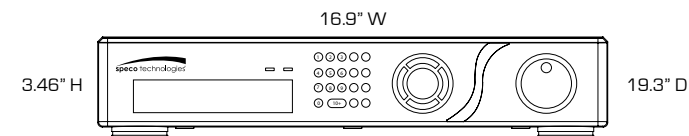

HDcctv Digital Video Recorders



DVR4HD/DVR82HD are the new generation of digital video recorders with HD quality live and recorded video. Our high definition DVRs will complement Speco Technologies HDcctv camera line. High definition is great for viewing details such as a person's face, reading a license plate or using a single camera to cover a large area. The user gets high speed digital video over coax cable with no compression or bandwidth issues.

720P 4 HD Channels



DVR4HD

- Megapixel performance over coax
- No networking challenges
- Able to zoom both live and playback
- Easy existing CCTV system upgrades
- No special installer training necessary
- Exceeds end user's expectations
- Same video quality as HDTV
- Simple to program
- Free iPhone® app available from iTunes®

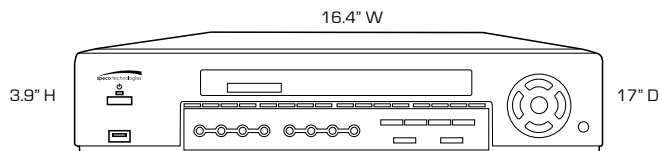

1080P 8 Analog + 2 HD Channels



DVR82HD

- Hybrid DVR - 2 channels 1080p + 8 channels D1
- High definition megapixel performance over coax
- No Networking challenges
- Able to zoom both live and playback
- Easy existing CCTV system upgrades
- No special installer training necessary
- Exceeds end user's expectations
- Same video quality as HDTV
- Simple to program
- Free iPhone® app available from iTunes®

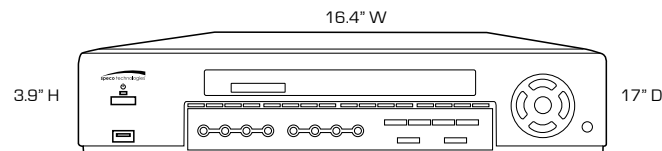

For full line of products and detailed product specs - visit specotech.com



**Built-In
GPS!**

H.264 Four Channel Mobile DVR with Cloud Archiving



D4M500

*Perfect for installations in
buses, emergency vehicles,
police cars, trains and more!*

- True H.264 standard video compression
- Embedded Linux system to give you the ultimate reliability
- Dedicated database structure for stability
- Cloud Archiving – Data can automatically be pushed off HDD through the network to a central server
- Compact Size for In-Vehicle installation
- Multi Storage Support – 2.5" Removable HDD, SD Card and USB
- Built-in GPS for E-Map Application
- Camera power provided by DVR

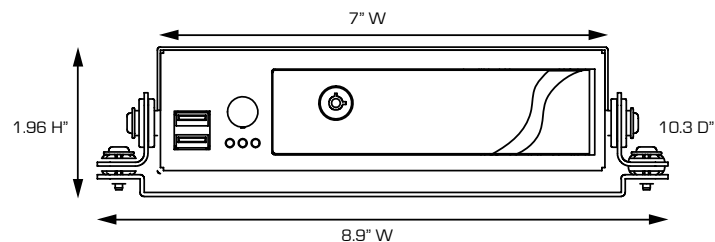

The D4M provides the cutting edge of mobile solutions for any type of transportation vehicle. This DVR was built upon industrial specification that offers the most reliable mobile solutions ever. It can withstand any harsh condition including shock, vibration and temperature changes.

Specifications

- GPS data can overlay location, speed and record with video for Mobile DVR
- Max. 120 FPS
- 4 Channels synchronized audio
- 4 level image quality setting
- Pre-alarm and post-alarm recording
- Panic alarm allows for emergency recording in full frame rate of every channel
- Supported copy media: USB memory stick, External USB HDD
- Driving Information (warning lights, brakes, turn signals)
- Impact sensor detects excessive gravitational forces on X, Y, Z axis
- 3 year warranty

Note: The D4M is designed to be installed in a vehicle. If planning on using the D4M in a home or business application; please visit specotech.com for recommended accessories.



For full line of products and detailed product specs - visit specotech.com

Flat Panel Color LED Monitors



Our high resolution flat screen LED monitors offer convenient on screen display controls for vertical and horizontal positioning and volume. It also features audio with rear mounted speakers. A 12VDC power supply is included.



VM19LED 19"
VM17LED 17"

Specifications

- Displays up to 16.7 million colors
- 1280(H) x 1024(V) SXGA resolution
- Built-in speakers
- Convenient front controls for screen programming
- Input signal detection provides easy connection
- 290cd/m2 Brightness
- 500:1 Contrast ratio
- HDMI, VGA (D-Sub 15 pins), audio, video inputs
- Regulated 12VDC 40W power supply (UL & CSA listed)
- VESA compatible

**ECO-FRIENDLY • LOW ENERGY CONSUMPTION
GREENER THAN LCDs**

For full line of products and detailed product specs - visit specotech.com

Remote Access Made Easy!



**AVAILABLE AT
THE iTunes STORE.**

Set-Up Basic DVR & IP Camera Settings Wirelessly with Speco's iPad® Configurator Application

Speco Technologies Configurator™ solution is not just another Apple iPad® application. It was designed to answer the serious needs of integrators, video security installers and sales personnel in the security industry.

A Wireless Configuration Tool For Your iPad®

- Never set-up the basic IP camera & DVR front panel settings again
- Configure all Speco Technologies' DVR's & IP cameras in your office or anywhere in the world
- Save every location and configuration to modify at any time
- With the iPad's Wi-Fi connectivity, uploading saved configurations to Speco DVRs & IP cameras is easy

Sales Tool

- Build custom settings on the fly
- State-of-the-Art Presentation
- Show your clients exactly what their system will look like on an iPad®!



**Remember to save the IP address
for remote upgrade**

Speco Commander is an Apple iPhone® application that allows a user to login to a networked DVR that is shared by an iPhone®. Speco Commander users can view live, pre-recorded or event videos and with the proper login credentials, change settings on Speco's DVRs. The Speco Commander iPhone® application enables users to select from 1 to 4 cameras for live or pre-recorded viewing. When viewing pre-recorded video, the user is able to select a start date and time for the video as well as select which channels to view, using the same abilities as the live view screen.

The Speco Commander Apple iPhone application is now available at the iTunes store.



WiFi
3G/4G
Standard IP
Speco DDNS

2012 NEW VIDEO SECURITY PRODUCTS



Delivers High Definition,
High Speed Digital Video Over Coax



See Color In Near Darkness
Without IR LEDs



Intense-IR Function:
No Saturation, Vivid Image



Future Proof DVRs
Support Analog & IP Cameras



Digital Deterrent™ Audio/Visual
Crime Prevention



Toll Free: 1-800-645-5516 Metro NY: 631-957-8700
Contact us at: www.specotech.com
200 New Highway, Amityville NY, 11701

